

Turbulence characteristics of flow in a spiral corrugated culvert fitted with baffles and implications for fish passage

Ryan R. Morrison^{a,1}, Rollin H. Hotchkiss^{b,*}, Mark Stone^{c,2},
David Thurman^{d,3}, Alex R. Horner-Devine^{e,4}

^a HDR Engineering Inc., 1001 SW 5th Ave., Suite 1800, Portland, OR 97204-1134, United States

^b Brigham Young University, Civil and Environmental Engineering, 370 Clyde Building, Provo, UT 84602, United States

^c Desert Research Institute, 755 E. Flamingo Rd., Las Vegas, NV 89119, United States

^d Department of Civil and Environmental Engineering, University of Washington, Box 352700, Seattle, WA 98195-2700, United States

^e Department of Civil and Environmental Engineering, University of Washington, 306 More Hall, Box 352700, Seattle, WA 98195-2700, United States

ARTICLE INFO

Article history:

Received 4 October 2007

Received in revised form

9 October 2008

Accepted 13 October 2008

Keywords:

Fish

Culverts

Turbulence

Hydraulic structures

ABSTRACT

Baffles are often used to retrofit culverts to aid in fish passage. The objective of this experimental investigation was to compare the turbulent flow structure inside a full-scale spiral corrugated culvert fitted with sloped- and slotted-weir baffles to available turbulence descriptions for non-baffled culverts. In addition, the turbulent flow structure inside a full-scale culvert was compared to fish passage preferences.

Velocity measurements were taken in a 1.83 m-diameter, 12.2 m-long corrugated metal culvert fitted with sloped- and slotted-weir baffles using a Sontek Micro-Acoustic Doppler Velocimeter for flow rates of 0.043, 0.085, 0.113, and 0.198 m³/s and a culvert slope of 1.14%. Results showed there were only minor differences in the turbulent flow structure created by each baffle type. The most significant differences included higher lateral turbulent intensities on the edges of the jet created by the slotted-weir baffles, and higher turbulent kinetic energies on the left side of the culvert (looking downstream) caused by the sloped-weir baffles. Downstream from a slotted-weir baffle, a reduced velocity and streamwise turbulent intensity zone was found near the left edge of the flow that was similar to that found in the bare culvert. The sloped-weir baffles produced a less pronounced zone near the right edge of the flow. No significant relationships could be found between the turbulence results of this study and biological fish passage tests performed at the same experimental site due to the lack of substantial differences in streamwise and lateral turbulence intensity distributions downstream from the tested baffles.

© 2008 Elsevier B.V. All rights reserved.

* Corresponding author. Tel.: +1 801 422 6234; fax: +1 801 422 0159.

E-mail addresses: Ryan.Morrison@hdrinc.com (R.R. Morrison), rhh@byu.edu (R.H. Hotchkiss), mark.stone@dri.edu (M. Stone), thurman@u.washington.edu (D. Thurman), arhd@u.washington.edu (A.R. Horner-Devine).

¹ Tel.: +1 503 423 3700.

² Tel.: +1 702 862 5457.

³ Tel.: +1 206 543 7633.

⁴ Tel.: +1 206 685 3032.

1. Introduction

Culverts have traditionally been used to pass a wide range of flows safely underneath roadways or other structures. While this has been effective in ensuring the safety of the traveling public, it has often neglected to provide ecological continuity for aquatic organisms living in the waterway. Specifically, excessive velocities and inadequate depths within culverts block fish migration and disrupt fish spawning and feeding habits (Baker and Votapka, 1990).

Recent and ongoing efforts address fish and aquatic organism passage. Cross-sectionally averaged velocity has conventionally been used as the limiting condition for fish passage through culverts, but recent studies show that the turbulence characteristics of flow may influence fish passage more than velocity (Smith et al., 2006). Since the replacement of culverts can be expensive, they are often retrofitted with baffles to decrease velocities and increase water depths.

In order to evaluate the effectiveness of retrofit designs, it is important to evaluate the influence of installed baffles on velocity and turbulence distributions within culverts. Ead et al. (2002) examined velocity distributions in bare culverts and Richmond et al. (2007) examined turbulence intensities inside bare culverts, but no studies exist showing turbulence characteristics inside culverts retrofitted with baffles.

The objectives of this experimental investigation were to compare (1) the turbulence heterogeneity created by sloped-weir and slotted-weir baffles, and (2) turbulence parameters for non-baffled culverts.

2. Relevant research

Turbulence has been shown to influence fish habitat selection, behavior, and swimming ability. Several researchers have described the apparent influence of turbulence on habitat selection (i.e. Coutant and Whitney, 2000), but only a few studies have investigated it directly. Cotel et al. (2006) reported a correlation between turbulence intensity focal positions of brown trout. Smith et al. (2006) concluded that the physical link between habitat complexity and turbulence production correlated with fish density by studying rainbow trout. Further, Smith and Brannon (2007) found that turbulence caused by habitat features, such as large rocks, resulted in a statistically meaningful difference in flow characteristics near cover. Many studies have also investigated the influence of turbulence on fish swimming performance. Enders et al. (2003) found that swimming costs were affected by the level of turbulence. In one investigation turbulence intensity explained 14% of the variation in total swimming costs (Enders et al., 2005). Liao et al. (2003) reported that trout swimming behind cylinders adopt a distinctive pattern of movement in order to hold station, in which body amplitudes and curvatures are much larger than when the cylinders were absent. Liao (2006) and Montgomery et al. (2000) described how the lateral line organ system is used for sensory processing by fish in order to respond to the turbulent flow field. Pavlov and Lupandin (1994) and Pavlov et al. (1994) and Lupandin (2005) investigated the influence of turbulence level on the critical swimming speed of multiple fish species.

To aid in the design of fish-passable culverts, extensive research has been conducted to describe the general flow characteristics inside a culvert fitted with baffles. Rajaratnam et al. (1988, 1989, 1991) developed an equation to describe the dimensionless discharge through a culvert fitted with multiple baffle types. Also, Alvarez-Vazquez et al. (2008) presented a mathematical formulation for an optimal design of baffles in a vertical slot fishway and Kim (2001) investigated the creation of resting places under various weir configurations. Although the general flow field in a baffled culvert has been thoroughly studied, no information could be found regarding the turbulence distribution inside a baffled culvert. Pearson et al. (2005) mention that turbulence conditions near the boundary layer of corrugated culverts may be important because turbulent velocity bursts could exceed the swimming ability of fish, and Papanicolaou and Talebbeydokhti (2002) comment that a three-dimensional analysis should be considered when designing culverts for fish suitability. Therefore it is important to understand the turbulence structure of flow in a culvert fitted with baffles for fish passage design.

Thurman et al. (in press) summarizes the results of a biological fish passage study for an experimental setup identical to the one used in this study. The biological tests were performed for flow rates ranging from 0.042 to 0.340 m³/s and a culvert slope of 1.14%. Sloped-weir baffles were spaced 4.57 m apart. Results show that when swimming upstream during a 0.042 m³/s flow rate, fish crossed the baffle center. For flow rates between 0.042 and 0.085 m³/s, fish crossed along the entire length of the baffle. At flow rates greater than 0.085 m³/s, fish crossed along the outer edges of the baffle when swimming upstream. Fish passage success rates peaked during intermediate discharge rates. The influence of local hydrodynamic conditions on fish swimming capabilities under various baffle configurations was also described in terms of flow velocities and pool size by Rodriguez et al. (2006).

Turbulence is often described by calculating the turbulent kinetic energy (TKE) and turbulent intensity (TI) of the flow. Turbulent kinetic energy can be calculated at any location in the flow:

$$TKE = \frac{u'_i u'_i}{2} \quad (1)$$

where u'_i represents the velocity fluctuation in the streamwise, transverse, and vertical directions, and the overbar represents the temporal mean (Mathieu and Scott, 2000). The TKE represents energy that is extracted from the mean flow due to shear between the mean and fluctuating velocities and gradients in the mean velocity field (Reynolds, 1974). In most natural stream channels, TKE decays exponentially away from the channel bed, whereas velocity typically increases away from the bed in a typical open channel.

Turbulence intensities can be calculated for each direction of flow:

$$TI_i = \left(\overline{u'^2_i} \right)^{1/2} \quad (2)$$

Calculations for TI represent the degree of fluctuation around the mean velocity in a given direction, with higher numbers indicating more turbulence (Reynolds, 1974).

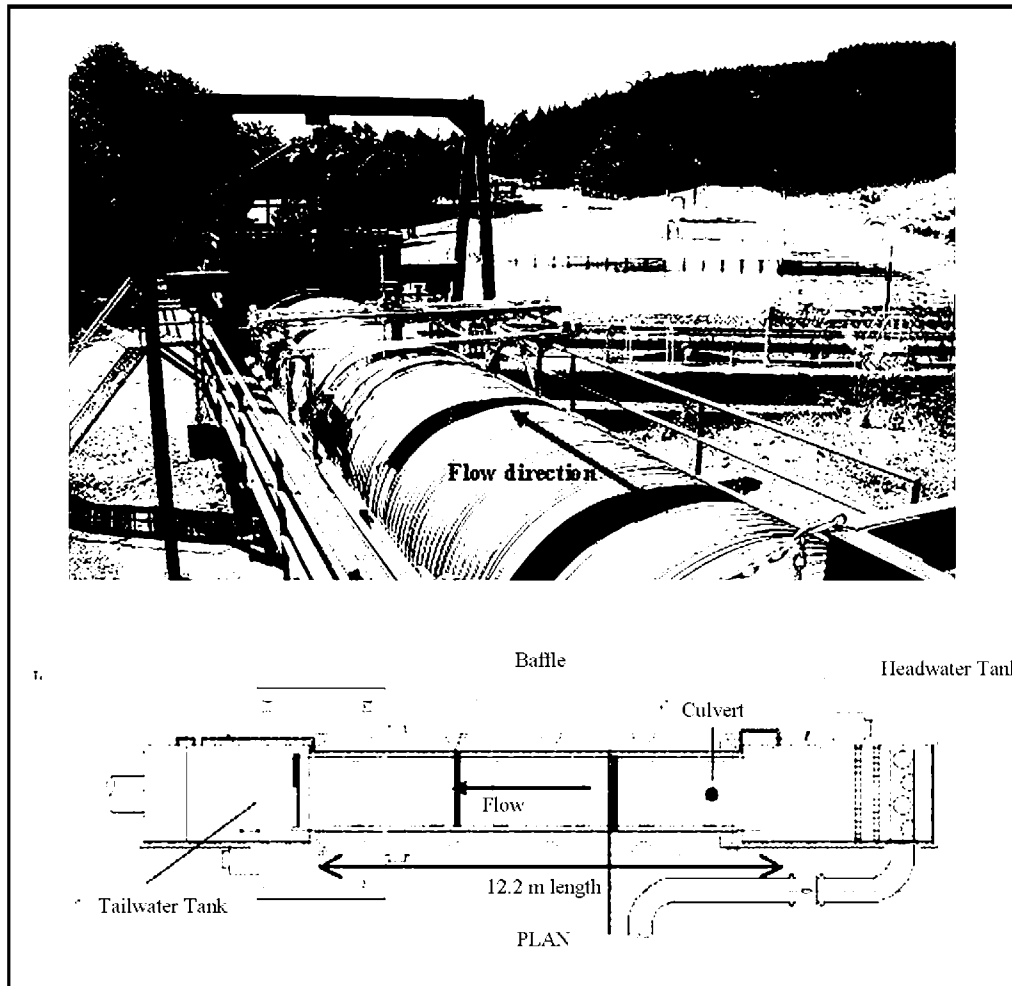

Fig. 1 – The Culvert Test Bed (CTB) facility located at the Skookumchuck Hatchery near Tenino, WA.

Work performed by Richmond et al. (2007) gives information about the turbulence intensity inside a bare spiral corrugated culvert, and describes the formation of a reduced velocity and turbulent intensity zone on one side of the flow. The redistribution of velocity was caused by secondary currents induced by the spiral corrugations in the culvert. The streamwise velocity and turbulence intensity in the reduced velocity zone (RVZ) was approximately 36% and 60% of the velocity and turbulence intensity in the center of the culvert (Richmond et al., 2007). The Richmond et al. study was performed at the Skookumchuck Hatchery near Tenino, Washington where a portion of this experimental study was also conducted, and the researchers used similar methodologies to those outlined below.

3. Experimental setup and methodology

Velocity data were collected in 1.83-m diameter, 12.2-m long culvert barrels at two sites: the Culvert Test Bed (CTB) located at the Skookumchuck Hatchery near Tenino, WA, and in the Albrook Hydraulics Laboratory at Washington State University, Pullman, WA.

At the CTB, the culvert was set at a 1.14% slope with six hatches cut into the top to allow access to the flow (Fig. 1). Three sloped-weir baffles were spaced 4.6 m apart in the culvert, with the first baffle located 2.1 m from the inlet. The baffle crests were sloped at 4° with the high side of the baffle located on the right side of the culvert when looking downstream (Fig. 2(a)). A baffle slope of 4° was a standard set by the Washington Department of Fish and Wildlife (WDFW) for retrofitted culverts. To be consistent with field retrofit criteria, this experiment followed WDFW criteria for baffle spacing and slope. The baffles were placed inside culvert spiral troughs. Data were collected at six cross-sections along the length of the culvert; five cross-sections were measured using a coarse grid of 23 points, and one cross-section was measured using a fine grid of 39 points (Fig. 3). Table 1(a) gives the location of each cross-section. Flow rates of 0.043, 0.057, 0.085, 0.113 and $0.227 \text{ m}^3/\text{s}$ were used in the tests and measured using a magnetic digital flow meter (accuracy of $\pm 1\%$). The Richmond et al. study was also performed at the CTB and used methodologies similar to this experimental investigation.

A replicate of the culvert installed at the CTB was used in the Albrook Hydraulics Laboratory, except the top of the culvert was completely removed allowing access to the flow

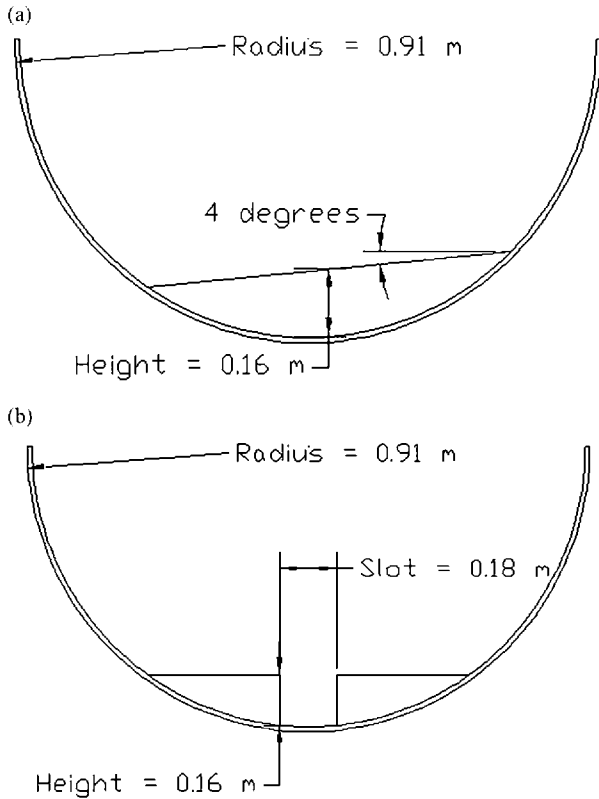

Fig. 2 – Culvert cross-section with the installation of (a) sloped-weir baffle and (b) slotted-weir baffle. Both views are looking downstream.

along the entire length of the culvert (Fig. 4). Sloped-weir and slotted-weir baffles (Fig. 2) were both tested with the same spacing as at the CTB at a culvert slope of 1.14%. Data were collected at three coarse grid cross-sections and three fine grid cross-sections (Fig. 3 and Table 1(b)). The cross-section locations were chosen so that the collected data would be

Table 1 – Location of each measurement cross-section for the (a) Culvert Test Bed Setup (b) Albrook Lab Setup.

Cross-section	Distance from Inlet (m)	Grid type
(a) Culvert Test Bed Setup		
Baffle 1	2.14	~
1	2.87	Coarse
2	5.00	Coarse
Baffle 2	6.71	~
3	7.01	Fine
4	7.25	Coarse
5	9.16	Coarse
6	11.02	Coarse
Baffle 3	11.28	~
(b) Albrook Hydraulics Laboratory Setup		
Baffle 1	2.14	~
1	5.00	Coarse
Baffle 2	6.71	~
2	7.01	Fine
3	7.25	Fine
4	8.07	Fine
5	9.16	Coarse
6	11.02	Coarse
Baffle 3	11.28	~

reasonably representative of the flow field downstream of a baffle. Because it was assumed the flow field changes most rapidly directly downstream from a baffle, the number of cross-sections in this area were greater than the number of cross-sections farther downstream. Finer data collection grids were also used at cross-sections directly downstream of a baffle (Table 1(b)). Because cross-section locations varied slightly between the CTB and Albrook setups, data from the CTB was only analyzed at locations where a matching cross-section existed in the Albrook setup. Flow rates of 0.043, 0.085, 0.113, and 0.198 m³/s were used and measured with a magnetic digital flow meter (accuracy of ±0.0003 m³/s).

A Sontek 16 MHz Micro-Acoustic Doppler Velocimeter (ADV) was used to collect velocity data at a 50 Hz sampling

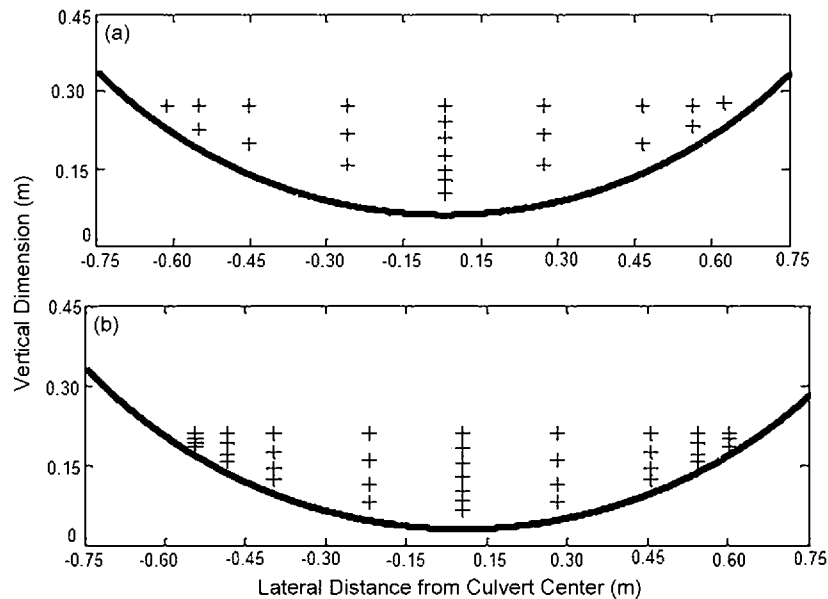

Fig. 3 – Measurement locations for (a) coarse grid (b) fine grid.

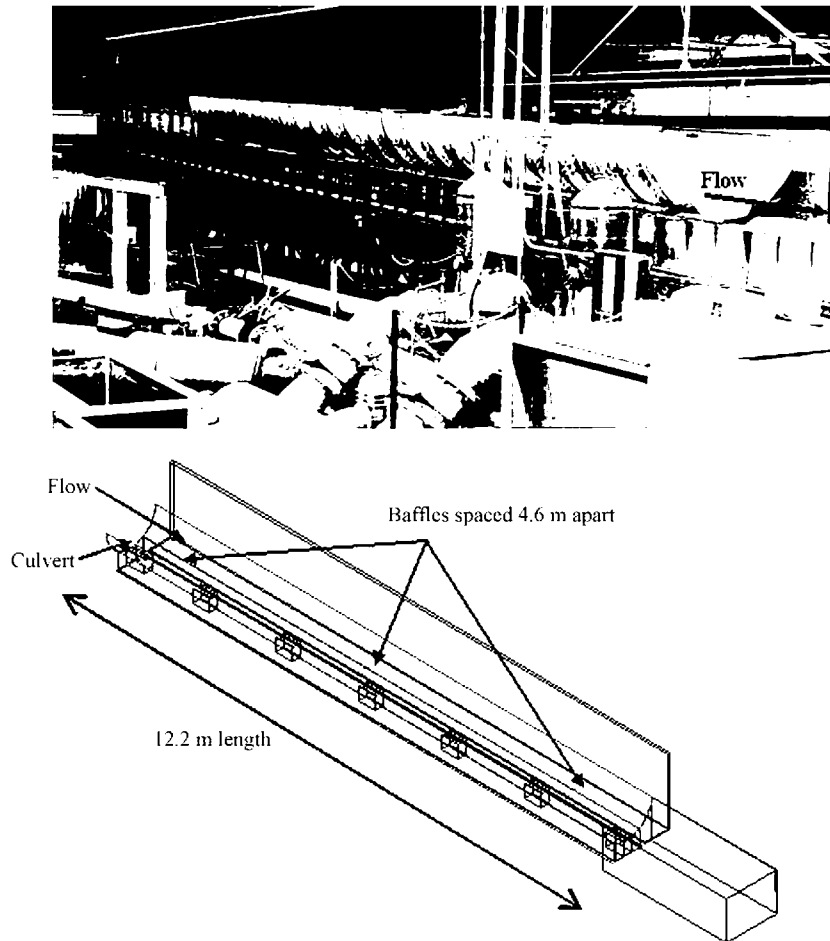

Fig. 4 – The test culvert located at the Albrook Hydraulic Laboratory, WSU, Pullman.

rate for 2 min (yielding 6000 data points). Two minute sampling intervals were deemed sufficient based on the convergence of velocity and higher order statistics using the techniques described by Stone and Hotchkiss (2007). The sampling volume of the MicroADV is located about 5 cm from the probe tip and is cylindrical with a diameter of 4.5 mm and length of 5.6 mm. According to the manufacturer, the instrument can measure velocities between 1 and 2.5 m/s with an accuracy of $\pm 1\%$ (Sontek, 2000). The MicroADV was mounted on a gantry system that could be moved to a specific location within 0.25 mm in any of three dimensions. The collected data were processed using WinADV (Wahl, 2000), and the phase-space thresholding method described by Goring and Nikora (2002) was used to filter out spikes caused by air bubbles passing through the sampling volume. Data with a signal-to-noise ratio (SNR) less than 10 dB and correlation less than 20% were filtered out. Calculations for average velocities, TI, and TKE were performed using custom FORTRAN and MATLAB codes.

4. Results and discussion

The challenges associated with conducting ADV measurements in a complex flow somewhat limited the amount of data

available for analysis. Data quality was highest when the flow velocity was low and the depth was high. When the flow velocity became too great, air bubbles were entrained on the probe tip reducing the SNR and creating high scatter in the data. Also, at depths less than approximately 7 cm, the acoustic backscatter off the culvert bottom produced erroneous data. As much as 30% of the data collection points were discarded when the data were filtered to account for these issues. The determination of how much data to discard was done using convergence of turbulence parameters and higher order statistics using the techniques described by Stone and Hotchkiss (2007). Data were presented from selected cross-sections to best illustrate changes or trends in velocity, TKE, or TI.

5. General flow structure

The sloped-weir baffles produced three distinct flow features (Fig. 5(a)). A plunge line formed directly downstream from the baffle, extending from the high side of the baffle (right side) toward the low side (left side) at an angle approximately 25° relative to the baffle. On the low side of the baffle, a high-velocity jet formed which became less distinct downstream. To the right of the jet and downstream from the plunge line a recirculation area formed, with the flow circulating clockwise.

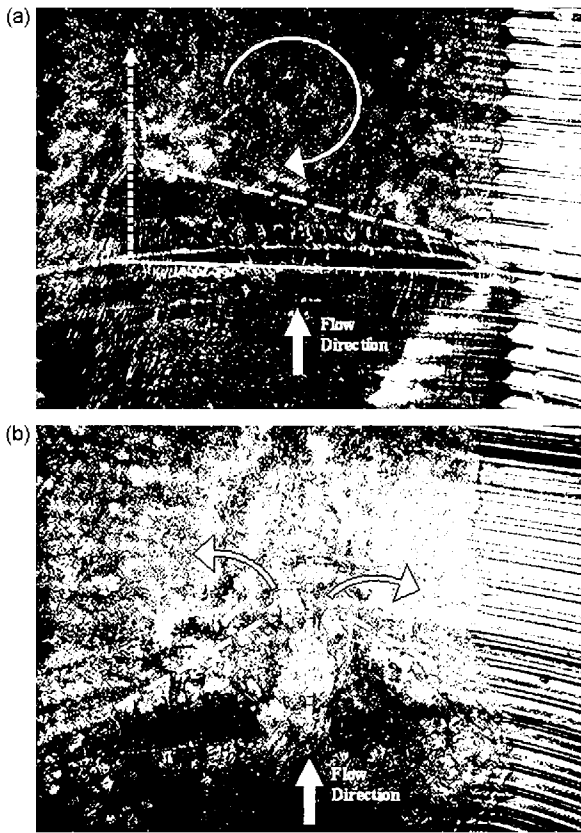

Fig. 5 – General flow structure from (a) sloped-weir baffles and (b) slotted-weir baffles. Plunge line—long dashed line; recirculation—solid line; jet—short dashed line.

The slotted-weir baffles produced a plunge line which also occurred directly downstream from the baffle and a high-velocity jet in the center of the culvert. The plunge line occurred at an angle approximately 45° relative to the baffle. Small areas of flow directed away from the center of the culvert formed on both edges of the jet (Fig. 5(b)).

At flow rates less than or equal to 0.085 m³/s, directly downstream from a sloped-weir baffle (0.31 m), the streamwise velocity was highest on the low side of the baffle (Fig. 6). At flow rates greater than 0.085 m³/s, high-streamwise velocities existed on both sides of the flowfield (Figs. 6 and 7(a)). At 4.32 m downstream from a sloped-weir baffle, the high-streamwise velocities on both sides of the flowfield existed at all flow rates. The lateral velocity distribution showed the flow directed toward the center of the culvert after it plunged over the baffle (Fig. 7(b)).

The slotted-weir baffles produced a jet in the center of the culvert, creating high-streamwise velocities in the center of the culvert for all flow rates and culvert slopes (Fig. 8). The jet was most noticeable directly downstream from a baffle and decreased in intensity farther downstream (Figs. 8 and 9(a)). A reduced velocity zone (RVZ) was also noticeable on the left side of the flowfield when using slotted-weir baffles. Lateral velocity distributions showed the flow was directed away from the centerline jet (Fig. 9(b)).

6. Turbulent kinetic energy distribution

The vertically-averaged centerline TKE values for the sloped- and slotted-weir baffles were very similar (Fig. 10). The highest values of TKE occurred within one meter downstream from a baffle, with a peak value of 0.84 m²/s². Farther downstream the TKE values dissipated to a level comparable to values recorded upstream from a baffle, and almost always remained below 0.1 m²/s². As a comparison, the Tritico and Hotchkiss (2005) study in gravel bed rivers describe unobstructed TKE values around 0.015 m²/s² and maximum TKE values directly downstream from boulders around 0.08 m²/s². Stone and Hotchkiss (2007) observed TKE values in a cobble bed river reach ranging from 0.03 m²/s² in a deep pool to 6.40 m²/s² in a riffle. The wide range of TKE values was attributed to relative roughness and other hydraulic properties including the Froude number.

The general shape of the lateral distributions of TKE did not vary between the two baffle types (Fig. 11). At 0.31 m downstream from a sloped-weir baffle for a 1.14% culvert slope, the vertically-averaged lateral TKE distribution was fairly constant with a slight increase at the left side of the culvert for flow rates below 0.198 m³/s. The small increase in TKE occurred near where the flow reached its highest velocity over the low side of the baffle.

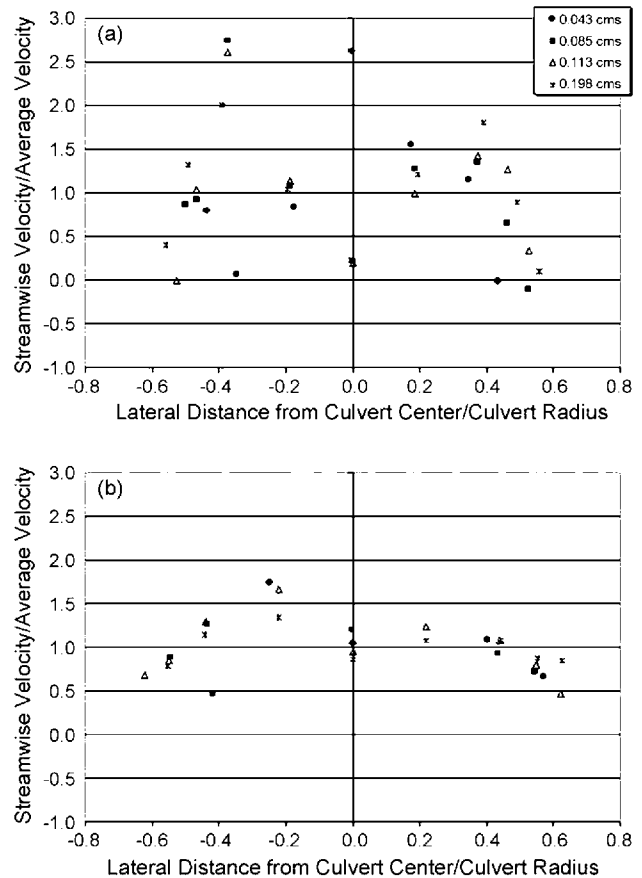

Fig. 6 – Streamwise velocity profiles looking downstream for sloped-weir baffle and 1.14% culvert slope (a) 0.31 m downstream from a baffle and (b) 4.32 m downstream from a baffle.

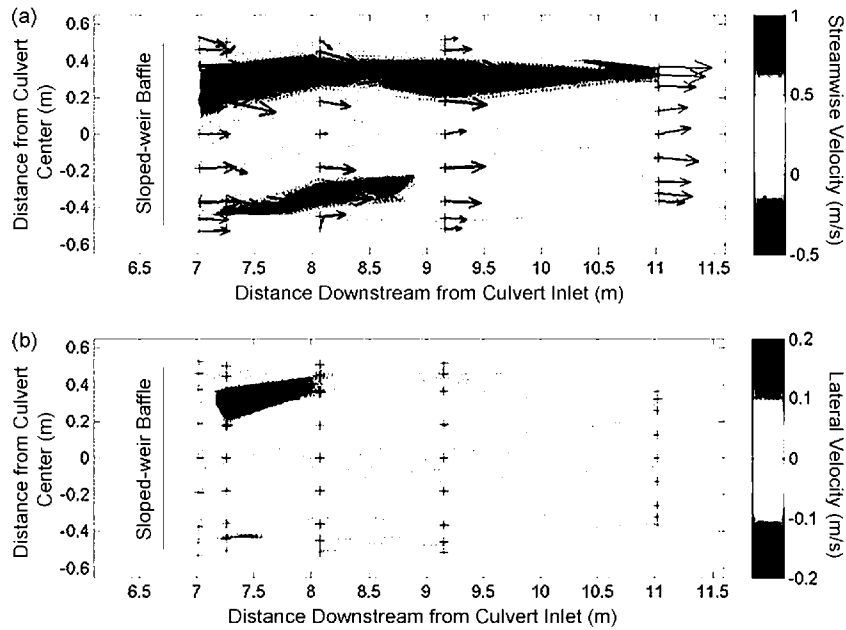

Fig. 7 – Velocity contour plots showing (a) streamwise velocity and (b) lateral velocity downstream of the central sloped-weir baffle. Positive V_y values are directed toward the top of the page. The cross marks represent measurement locations. The flow rate is $0.198 \text{ m}^3/\text{s}$ and the culvert slope is 1.14%.

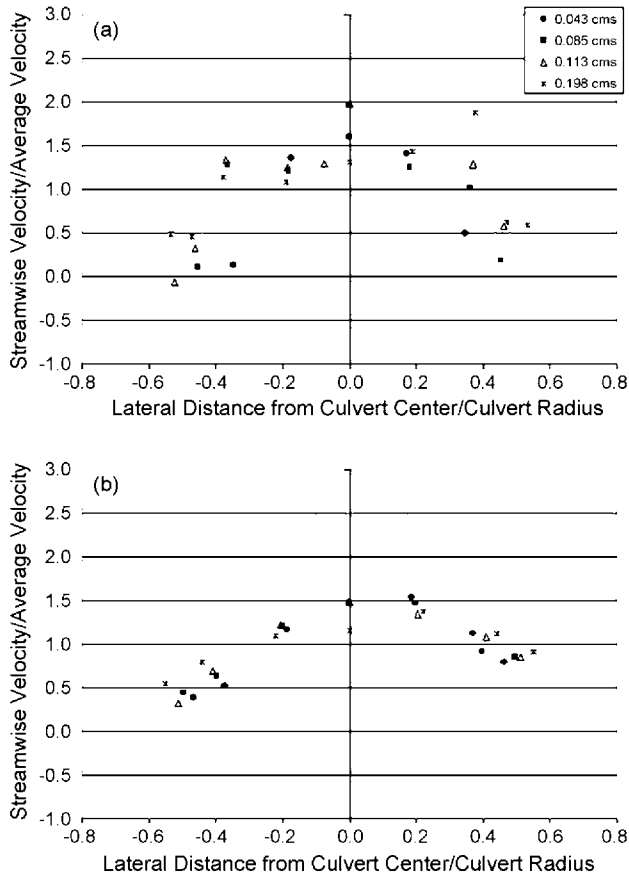

Fig. 8 – Streamwise velocity profiles with a slotted-weir baffle and 1.14% culvert slope (a) 0.31 m downstream from a baffle and (b) 4.32 m downstream from a baffle.

At 0.31 m downstream from a slotted-weir baffle, the lateral TKE distribution exhibited a small increase in TKE near the center and left side of the culvert for flow rates greater than $0.085 \text{ m}^3/\text{s}$ (Fig. 11). For flow rates equal to or less than $0.085 \text{ m}^3/\text{s}$ the rise in TKE in the center of the culvert was not evident. Farther downstream the lateral TKE distribution became relatively uniform for both baffle types. For all flow rates at downstream cross-sections, the TKE values were less than $0.1 \text{ m}^2/\text{s}^2$.

Centerline TKE versus dimensionless height (Z/h) plots, where Z is the distance above the culvert bottom and h is the centerline water depth, showed that 1.37 m downstream from a sloped-weir baffle the TKE values were relatively uniform throughout the water depth (Fig. 12). This is contrary to TKE distributions in unobstructed open-channel flow, where the TKE decays exponentially away from the channel bed (Nezu and Nakagawa, 1993; Tritico and Hotchkiss, 2005), but was consistent with observations made by Stone and Hotchkiss (2007) in cobble-bed streams with high-relative roughness (0.12–0.33). For slotted-weir baffles, the TKE values decreased slightly or remained fairly uniform near the water surface (Fig. 12). At all flow rates the slotted-weir baffles created higher centerline TKE values than the sloped-weir baffles due to the jet in the culvert center.

7. Turbulence intensity distributions

Lateral profiles of vertically averaged streamwise turbulent intensity (TI_s) for both baffle types are shown in Fig. 13. Lateral TI_s profiles for the two baffle types displayed similar values. At 0.31 m downstream from a baffle the sloped-weir baffles produced a maximum TI_s of approximately 35 cm/s, and the slotted-weir baffles produced a maximum TI_s of approxi-

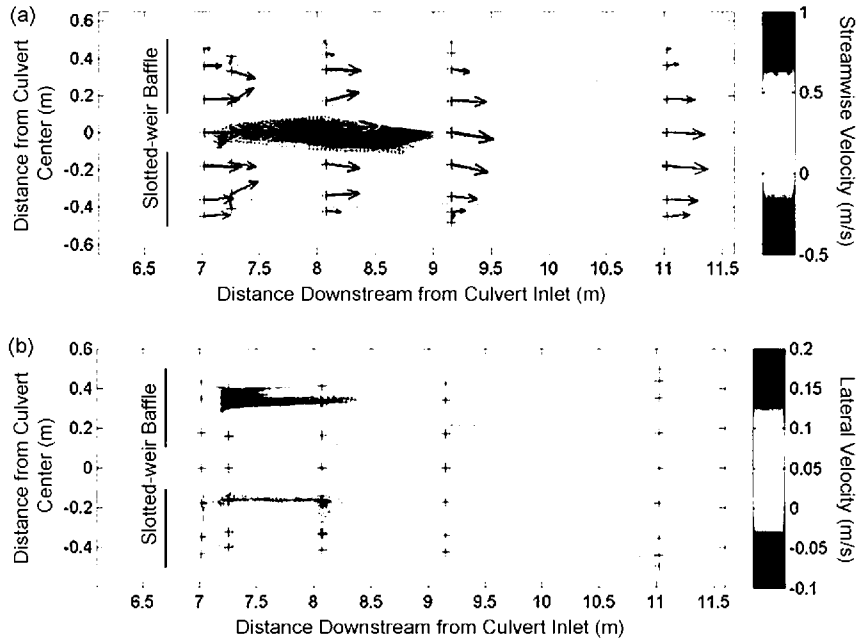

Fig. 9 – Velocity contour plots showing (a) streamwise velocity at 0.113 m³/s and (b) lateral velocity downstream of the central slotted-weir baffle at 0.085 m³/s. Positive V_y values are directed toward the top of the page. The cross marks represent measurement locations. The culvert slope is 1.14%.

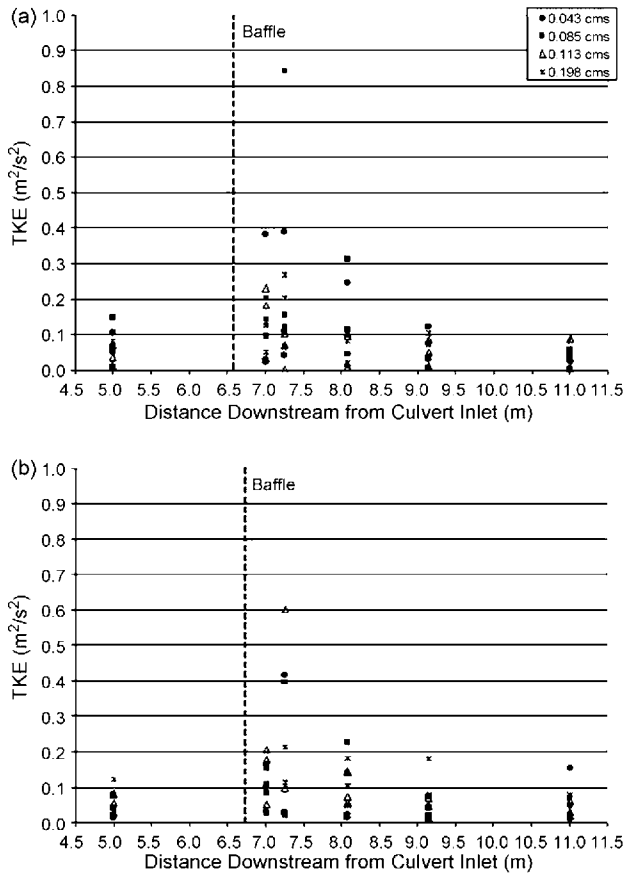

Fig. 10 – Vertically-averaged centerline TKE values at all slopes for (a) sloped-weir baffles and (b) slotted-weir baffles.

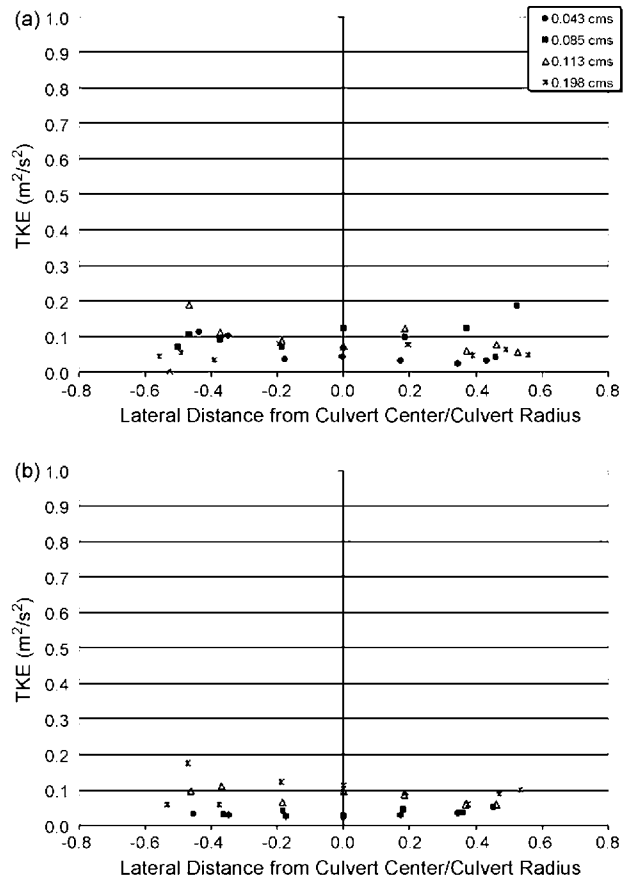

Fig. 11 – Lateral TKE distribution 0.31 m downstream from (a) sloped-weir baffle and (b) slotted-weir baffle with a 1.14% culvert slope.

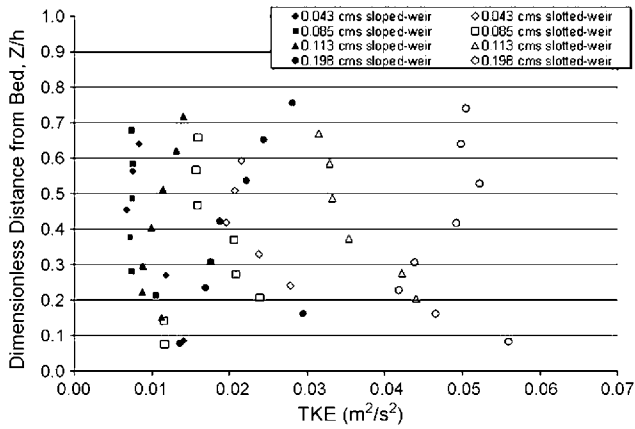

Fig. 12 – Centerline TKE profiles 1.37 m downstream with a 1.14% culvert slope for sloped-weir baffles and slotted-weir baffles.

mately 30 cm/s. At 4.32 m downstream the sloped-weir baffles produced a maximum TI_s of around 13 cm/s, while the slotted-weir baffles produce a maximum TI_s of approximately 14 cm/s. It is uncertain whether the lateral TI_s profiles at 0.31 m downstream from the baffles have similar distribution shapes as the slope increases. At 4.32 m downstream from the baffles the TI_s profiles show the same distribution shape as the culvert slope increases, but have increased TI_s values.

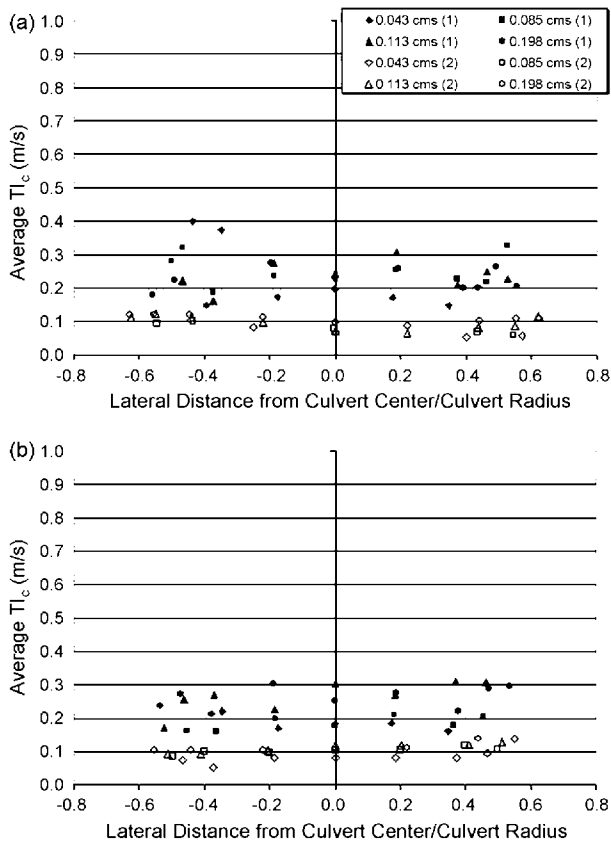

Fig. 13 – Vertically-averaged TI_s profiles 0.31 m (1) and 4.32 m (2) downstream with a 1.14% culvert slope for (a) sloped-weir baffle and (b) slotted-weir baffle.

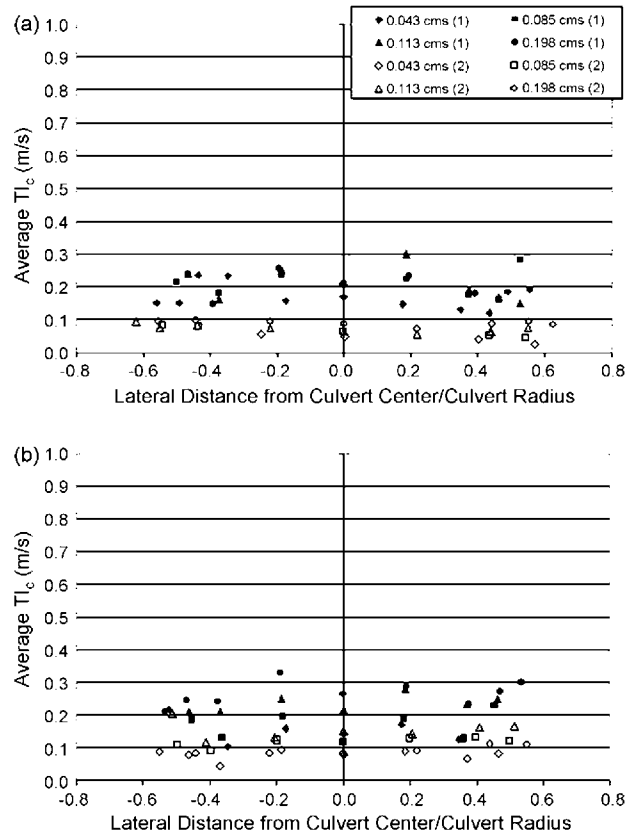

Fig. 14 – Vertically-averaged TI_l profiles 0.31 m (1) and 4.32 m (2) downstream with a 1.14% culvert slope for (a) sloped-weir baffle and (b) slotted-weir baffle.

There were minor variations in the lateral turbulent intensity (TI_l) profiles for the two baffle types. At 0.31 m downstream from a sloped-weir baffle, the TI_l was generally greatest near the low side of the baffle (Fig. 14), except for the flow rate $0.198 m^3/s$. With slotted-weir baffles there were minimum TI_l values in the center of the culvert with increased TI_l approximately 20 cm on either side of the culvert center (Fig. 14). No pattern was observed in the lateral TI_l distributions 4.32 m downstream from the baffles. Both baffle types showed similar distributions, except the TI_l values for the slotted-weir baffles are slightly greater than the values for sloped-weir baffles. The distributions at 4.32 m downstream were similar for all slopes tested.

8. Comparison to non-baffled culvert data

Data were compared to the Richmond et al. (2007) bare culvert study to examine changes in velocity and turbulence caused by sloped- and slotted-weir baffles. The Richmond et al. study provided comparable data for a 1.14% culvert slope and flow rates of 0.043 and $0.113 m^3/s$.

The RVZ produced inside a bare culvert was noticeable 4.32 m downstream from slotted-weir baffles near the left edge of flow (Fig. 15). In a bare culvert, the velocity in the RVZ was approximately 30% of the centerline velocity, while the RVZ produced by slotted-weir baffles was 22% of the centerline

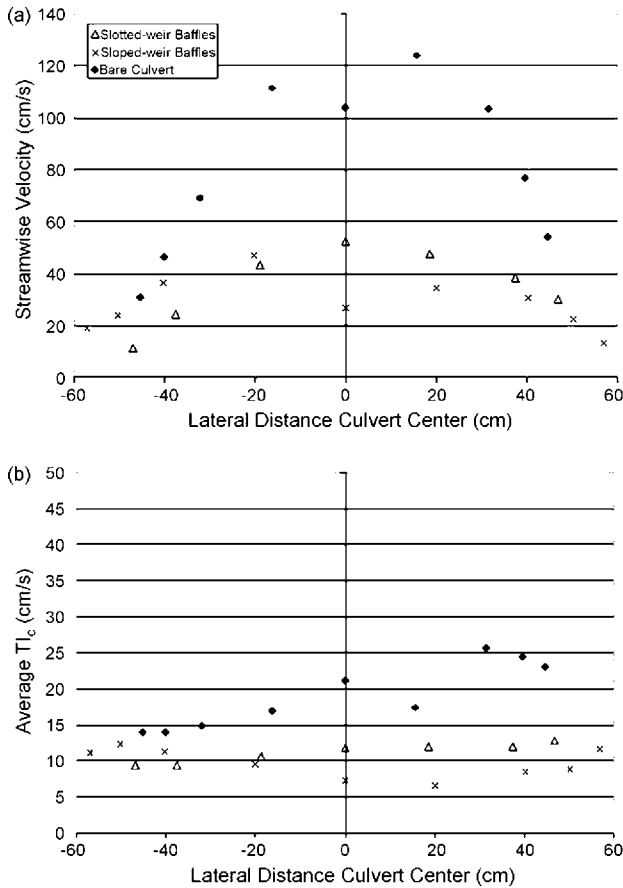

Fig. 15 – Comparison of bare culvert and baffled culvert data for a 1.14% slope and 0.113 m³/s flow rate for (a) streamwise velocity and (b) streamwise turbulent intensity.

velocity at a 0.113 m³/s flow rate. For a flow rate of 0.043 m³/s, both percentages were approximately 50%. With sloped-weir baffles, a smaller RVZ existed on the right side of the culvert, corresponding to the high side of the baffle (Fig. 15). The velocity in the RVZ for the sloped-weir baffle was 49% of the centerline velocity at 0.113 m³/s and 50% at 0.043 m³/s. The streamwise velocity magnitudes in a bare culvert were greater than the velocity magnitudes in a baffled culvert. This was expected since the flow area increased as water backed-up behind baffles.

The lateral TI_s profiles for a bare culvert also show an area of lower values on the left side of the flow (Fig. 15). In a bare culvert, the TI_s on the left side of the flow was approximately 66% of the centerline TI_s at 0.113 m³/s and 67% at 0.043 m³/s. At 4.32 m downstream from a slotted-weir baffle, the TI_s on the left side was 79% of the centerline TI_s at 0.113 m³/s and 63% at 0.043 m³/s. The flow downstream from a sloped-weir baffle had reduced TI_s values near the center of the culvert, but did not exhibit a reduced TI_s area on any particular side of the flow (Fig. 15).

At 0.31 m downstream from a slotted-weir baffle a more noticeable RVZ existed on the left side of the culvert. The velocity in the RVZ was an average 10% of the streamwise velocity in the center of the culvert for flow rates 0.043 and 0.113 m³/s. There was not a reduced TI_s at the same location

downstream from a slotted-weir baffle. A RVZ or reduction in TI_s did not exist 0.31 m downstream from a sloped-weir baffle.

9. Summary and implications

The first objective of this research was to compare the turbulent heterogeneity produced by sloped- and slotted-weir baffles. Results reveal only minor differences in the turbulence distributions for the two baffle types. The differences in the turbulence distributions were due to the variations in the general flow structure created by each baffle. For all flow rates below 0.198 m³/s, the lateral TKE distribution for the sloped-weir baffles showed a slight increase in TKE on the low (left) side of the baffle. The increase in TKE was due to a greater shear zone between the high-streamwise velocity region on the low side of the baffle and the slower moving water in the center of the culvert. The increase in TKE and TI_l near the center of the culvert with slotted-weir baffles was caused by strong lateral velocities away from the central jet. The strong lateral velocities produced spikes in TI_l approximately 20 cm away from the culvert center, as well as slight increases in TKE near the center of the culvert for flow rates less than 0.198 m³/s.

The effects of the general flow structure were not noticeable 4.32 m downstream from a baffle, thus there were almost no variations in turbulence parameters between the two baffle types at this location. The centerline TKE values returned to levels recorded upstream of the previous baffle, and lateral TKE distributions did not vary.

Two-dimensional, uniform, steady flow with low-relative roughness is known to produce a TKE distribution that exponentially decays away from the channel bed (Nezu and Nakagawa, 1993; Tritico and Hotchkiss, 2005). As seen in this study, the introduction of baffles in a culvert does not fit the criteria described above and the centerline TKE values showed very little variation throughout the water column for most experiments in this study.

Although the turbulent flow structures created by each baffle were similar, there were major differences in the downstream velocity distributions. Because it was found that the turbulence downstream from each baffle type were similar, more information could be gathered about the general flow structure by more closely examining mean velocity distributions rather than turbulence parameters. Furthermore, if creating flow field heterogeneity is a desired function of baffles in culverts (Rajaratnam et al., 1989), more work is required to find baffle designs that create greater spatial variation in mean velocity and turbulence characteristics than those examined in these experiments.

No significant relationships could be found between the turbulence results of this study and the biological fish passage results outlined by Thurman et al. (in press). Biological tests found that the location at which fish prefer to cross a baffle differs depends upon the flow rate, and that the greatest passage success rates occurred during flow rates between 0.042 and 0.083 m³/s. During the greatest passage success rates, fish crossed along the entire length of baffle. This study found that TKE did not vary directly downstream from a baffle except at 0.198 m³/s. Therefore it is difficult to determine

the impact that changes in TKE have on upstream swimming fish. The lack of substantial differences in TI_s and TI_l distributions downstream from a baffle also prevent this study from finding significant relationships between recorded turbulence parameters and fish passage preferences.

The second objective of this study was to compare velocity and turbulence data to the Richmond et al. (2007) bare culvert study. The extent of the evaluation was limited by the amount of comparable data in the Richmond et al. study. The RVZ produced inside a bare culvert on the left side of the flow was also produced 0.31 and 4.32 m downstream of a slotted-weir baffle for a slope of 1.14% and flow rates of 0.043 and 0.113 m³/s. In a bare culvert and one with slotted-weir baffles (4.32 m downstream), the streamwise velocity in the RVZ was approximately 36% of the velocity in the center region of the flow. At 0.31 m downstream from a slotted-weir baffle, the velocity in the RVZ was approximately 10% of the center region velocity. A RVZ was produced with sloped-weir baffles on the right side of the flow 4.32 m downstream, corresponding to the high side of the baffle. This RVZ contained a velocity approximately 50% of the velocity in the center region of the flow.

In both a bare culvert and one with slotted-weir baffles, an area of reduced TI_s was produced on the left side of the flow. The TI_s in this area was approximately 67% of the TI_s in the center of a bare culvert, and 71% of the TI_s in the center of a culvert with slotted-weir baffles. The sloped-weir baffles did not create an area of reduced TI_s on a particular side of the flow.

The RVZ and reduced TI_s reported by Richmond et al. (2007) have been utilized by juvenile salmon during upstream passage through culverts. The addition of slotted-weir baffles does not create a more pronounced RVZ when compared to center-of-culvert velocities 4.32 m downstream from a baffle; however, the RVZ was more pronounced 0.31 m downstream. Velocities downstream of slotted-weir baffles were less than those in a bare culvert at comparable slopes and discharges. The RVZ created by slotted-weir baffles could be utilized more by juvenile salmon since overall velocities are less than in a bare culvert, and are especially important near the baffle where velocities are high in the center of the culvert. Testing to date has not yet provided data on this specific potential improving passage.

According to Smith et al. (2006), structures with simplified geometries and sharp edges (such as baffles) create higher turbulence levels than natural objects and could reduce habitat suitability. It is therefore important to further evaluate the three-dimensional flow structure around commonly installed baffles and assess their usefulness in improving fish passage. This study showed how the addition of baffles can create areas of reduced velocity and turbulence and can produce flow structures different than those in a bare culvert depending on the selected baffle type, but large data gaps still exist at slopes greater than 1.14%. More research should be conducted with steeper slopes and decreased baffle spacing to help improve design techniques for fish passage and to provide accurate equations and methods for determining fish passage barriers within the flow structure.

In future tests it is recommended that the baffle spacing decrease as the culvert slope increases. At a 1.14% slope the

baffle spacing followed the Washington Department of Fish and Wildlife criteria of calculating the spacing as 0.02 divided by the culvert slope. However, the same spacing of 4.6 m was used for all slopes, deviating from the WDFW criteria. Further experiments should follow the WDFW criteria at higher slopes. Decreased baffle spacing would also improve the quality of data collected since less data would be filtered out due to erroneous data created by shallow depths and excessive velocities.

The results of this study have improved knowledge of flow heterogeneity in culverts with two alternative baffle designs. This is significant given recent efforts to retrofit culverts with baffles to improve fish passage.

REFERENCES

- Alvarez-Vazquez, L.J., Martineza, A., Vazquez-Mendez, M.E., Vilar, M.A., 2008. An optimal shape problem related to the realistic design of river fishways. *Ecol. Eng.* 32 (4), 293–300.
- Baker, C.O., Votapka, F.E., 1990. Fish Passage Through Culverts. Rep. No. FHWA-FL-90-0006.
- Cotel, A.J., Webb, P.W., Tritico, H., 2006. Do brown trout choose locations with reduced turbulence? *Trans. Am. Fisheries Soc.* 135 (3), 610–619.
- Coutant, C.C., Whitney, R.R., 2000. Fish behavior in relation to fish passage through hydropower turbines: a review. *Trans. Am. Fisheries Soc.* 129, 351–380.
- Ead, S.A., Rajaratnam, N., Katopodis, C., 2002. Generalized study of hydraulics of culvert fishways. *J. Hydraul. Eng.* 128 (11), 1018–1022.
- Enders, E.C., Boisclair, D., Roy, A.G., 2003. The effect of turbulence on the cost of swimming for juvenile Atlantic salmon (*Salmo salar*). *Can. J. Fisheries Aqua. Sci.* 60 (9), 1149–1160.
- Enders, E.C., Boisclair, D., Roy, A.G., 2005. A model of total swimming costs in turbulent flow for juvenile Atlantic salmon (*Salmo salar*). *Can. J. Fisheries Aqua. Sci.* 62 (5), 1079–1089.
- Goring, D.G., Nikora, V.I., 2002. Despiking acoustic Doppler velocimeter data. *J. Hydraul. Eng.* 128 (1), 117–126.
- Kim, J.H., 2001. Hydraulic characteristics by weir type in a pool-weir fishway. *Ecol. Eng.* 16 (3), 425–433.
- Liao, J.C., Beal, D.N., Lauder, G.V., Triantafyllou, M.S., 2003. The Karman gait: novel body kinematics of rainbow trout swimming in a vortex street. *J. Exp. Biol.* 206 (6), 1059–1073.
- Liao, J.C., 2006. The role of the lateral line and vision on body kinematics and hydrodynamic preference of rainbow trout in turbulent flow. *J. Exp. Biol.* 209 (20), 4077–4090.
- Lupandin, A.I., 2005. Effect of flow turbulence on swimming speed of fish. *Biol. Bull.* 32 (5), 461–466.
- Mathieu, J., Scott, J., 2000. *An Introduction to Turbulent Flow*. Cambridge University Press, Cambridge, United Kingdom.
- Montgomery, J., Carton, G., Voigt, R., Baker, C., Diebel, C., 2000. Sensory processing of water currents by fishes. *Philos. Trans. Royal Soc. London Ser. B—Biol. Sci.* 355 (1401), 1325–1327.
- Nezu, I., Nakagawa, H., 1993. *Turbulence in Open-channel Flows*. Balkema, Rotterdam, The Netherlands.
- Papanicolaou, A., Talebbeydokhti, N., 2002. Discussion of ‘Turbulent open-channel flow in circular corrugated culverts’ by S.A. Ead, N. Rajaratnam, C. Katopodis, and F. Ade. *J. Hydraul. Eng.* 128 (5), 547–548.
- Pavlov, D.S., Lupandin, A.I., 1994. Response of fish on water currents with different degree of turbulence. *Doklady Akademii Nauk* 339 (3), 427–430.
- Pavlov, D.S., Lupandin, A.I., Skorobogatov, M.A., 1994. The influence of water current turbulence level on the critical

- swimming speed of gudgeon (*Gobio-Gobio*). *Doklady Akademii Nauk* 336 (1), 138–141.
- Pearson, W., Richmond, M., Johnson, G., Sargaent, S., Mueller, R., Cullinan, V., Deng, Z., Dibrani, B., Guensch, G., May, C., O'Rourke, L., Sobocinski, K., Tritico, H., 2005. Protocols for Evaluation of Upstream Passage of Juvenile Salmonids in an Experimental Culvert Test Bed. Rep. No. PNWD-3525. Richland, Washington.
- Rajaratnam, N., Katopodis, C., Lodewyk, S., 1988. Hydraulics of offset baffle culvert fishways. *Can. J. Civil Eng.* 15 (6), 1043–1051.
- Rajaratnam, N., Katopodis, C., McQuitty, N., 1989. Hydraulics of culvert fishways. II. Slotted-weir culvert fishways. *Can. J. Civil Eng.* 16 (3), 375–383.
- Rajaratnam, N., Katopodis, C., Lodewyk, S., 1991. Hydraulics of culvert fishways. IV. Spoiler baffle culvert fishways. *Can. J. Civil Eng.* 18 (1), 76–82.
- Reynolds, A.J., 1974. *Turbulent Flows in Engineering*. John Wiley, New York.
- Richmond, M.C., Deng, Z.Q., Guensch, G.R., Tritico, H., Pearson, W.H., 2007. Mean flow and turbulence characteristics of a full-scale spiral corrugated culvert with implications for fish passage. *Ecol. Eng.* 30 (4), 333–340.
- Rodriguez, T.T., Agudo, J.P., Mosquera, L.P., Gonzalez, E.P., 2006. Evaluating vertical-slot fishway designs in terms of fish swimming capabilities. *Ecol. Eng.* 27 (1), 37–48.
- Smith, D.L., Brannon, E.L., Shafii, B., Odeh, M., 2006. Use of the average and fluctuating velocity components for estimation of volitional rainbow trout density. *Trans. Am. Fisheries Soc.* 135 (2), 431–441.
- Smith, D.L., Brannon, E.L., 2007. Influence of cover on mean column hydraulic characteristics in small pool riffle morphology streams. *River Res. Appl.* 23 (2), 125–139.
- Sontek, 2000. *User's Manual*.
- Stone, M.C., Hotchkiss, R.H., 2007. Turbulence descriptions in two cobble-bed river reaches. *J. Hydraul. Eng.* 133 (12), 1367–1413.
- Thurman, D.R., Horner-Devine, A.R., Morrison, R., Hotchkiss, R.H., in press. Hydrodynamic regimes and structures in sloped weir baffled culverts and their influence on juvenile salmon passage. *J. Hydraul. Eng.*
- Tritico, H.M., Hotchkiss, R.H., 2005. Unobstructed and obstructed turbulent flow in gravel bed rivers. *J. Hydraul. Eng.* 131 (8), 635–645.
- Wahl, T.L., 2000. Analyzing ADV data using WinADV. In: 2000 Joint Conference on Water Resources Engineering and Water Resources Planning & Management, Minneapolis, Minnesota.